







	400068	400069	400079	400080	400081	400082
						
Dimensões						
ØA	8,0	17,0	18,9	18,6	23,0	-

Dimensões								
Tipo	Peça	Combinações						
A	1	101751	X	X				
	2	101917			X	X		
	3	500379	X			X		
	4	500380	X				X	
	5	500381		X	X		X	
	6	500382			X		X	
B	1	101923				X	X	X
	2	500383		X X				X
	3	500384		X		X		X
	4	500385		X			X	X
	5	500386				X X		X
	6	500387					X X	X

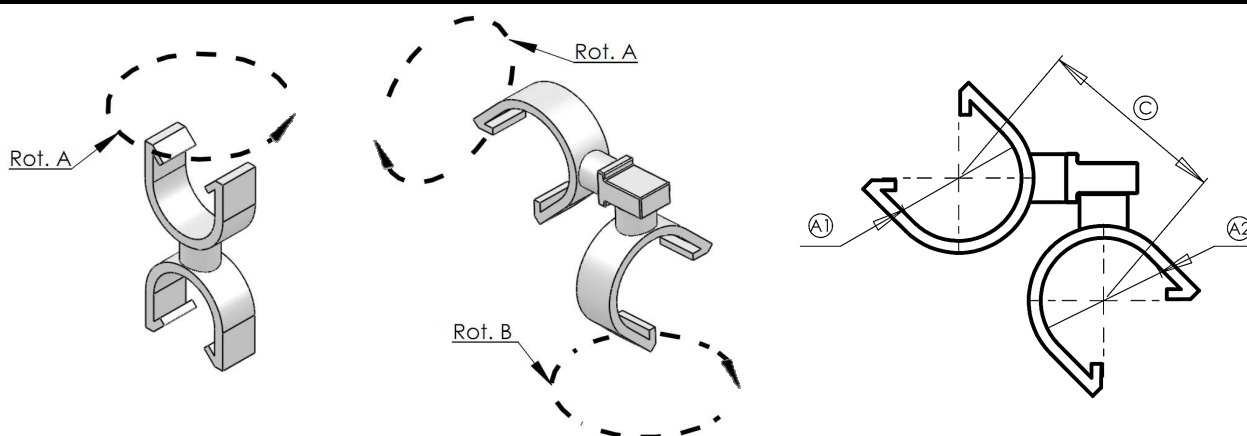

		Distância entre centros (Cota C)											
		Tipo A						Tipo B					
Rot. A	Rot. B	1	2	3	4	5	6	1	2	3	4	5	6
0°-180°	0°-180°	22,1	29,8	24,6	26,4	27,9	32,1	33,4	28,8	30,4	31,6	32,2	34,7
90°-270°	0°-180°	22,1	29,8	24,6	26,4	27,9	32,1	33,4	28,8	30,4	31,6	32,2	54,4
0°-180°	90°-270°	-	-	-	-	-	-	33,4	28,8	30,4	31,6	32,2	34,9
90°-270°	90°-270°	-	-	-	-	-	-	33,4	28,8	30,4	31,6	32,2	34,7